

IGBT Discrete

V_{CE}	650	V
I_C	75	A
$V_{CE(SAT)} I_C=75A$	1.45	V

Circuit

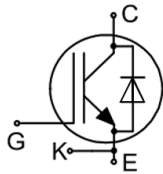

Applications

- Resonant converters
- Uninterruptible power supplies
- Welding converters
- Mid to high range switching frequency converters

Features

- High speed smooth switching device for hard & soft switching
- Maximum junction temperature 175°C
- Positive temperature coefficient
- High ruggedness, temperature stable

Maximum Ratings

Parameter	Symbol	Value	Unit
Collector-Emitter Breakdown Voltage	V_{CE}	650	V
DC Collector Current, limited by T_{jmax} $T_C=25^\circ C$ value limited by bondwire $T_C=100^\circ C$	I_C	85 80	A
Diode Forward Current, limited by T_{jmax} $T_C=25^\circ C$ value limited by bondwire $T_C=100^\circ C$	I_F	85 80	A
Continuous Gate-Emitter Voltage	V_{GE}	± 20	V
Transient Gate-Emitter Voltage ($t_p \leq 10\mu s, D < 0.010$)	V_{GE}	± 30	V
Turn off Safe Operating Area $V_{CE} \leq 650V$, $T_j \leq 150^\circ C$		300	A
Pulsed Collector Current, $V_{GE}=15V$, t_p limited by T_{jmax}	I_{CM}	300	A
Diode Pulsed Current, t_p limited by T_{jmax}	I_{Fpuls}	300	A
Power Dissipation, $T_j=175^\circ C, T_C=25^\circ C$	P_{tot}	428	W

Operating Junction Temperature	T_j	-40...+175	°C
Storage Temperature	T_s	-55...+150	°C
Soldering Temperature, wave soldering 1.6mm (0.063in.) from case for 10s		260	°C

Electrical Characteristics of the IGBT ($T_j = 25^\circ\text{C}$ unless otherwise specified):

Parameter	Symbol	Conditions	Min.	Typ.	Max.	Unit
Static						
Collector-Emitter Breakdown Voltage	BV_{CES}	$V_{GE}=0V, I_C=250\mu A$	650		-	V
Gate Threshold Voltage	$V_{GE(th)}$	$V_{GE}=V_{CE}, I_C=0.75mA$	3.2	4.0	4.8	V
Collector-Emitter Saturation Voltage	$V_{CE(sat)}$	$V_{GE}=15V, I_C=75A$ $T_j=25^\circ\text{C}$, $T_j=125^\circ\text{C}$ $T_j=150^\circ\text{C}$	1.10	1.45 1.60 1.70	1.75	V
Zero Gate Voltage Collector Current	I_{CES}	$V_{CE}=650V, V_{GE}=0V$ $T_j=25^\circ\text{C}$, $T_j=150^\circ\text{C}$			0.25 3.00	mA
Gate-Emitter Leakage Current	I_{GES}	$V_{CE}=0V, V_{GE}=\pm 20V$			100	nA

Parameter	Symbol	Conditions	Min.	Typ.	Max.	Unit
Dynamic						
Input Capacitance	C_{ies}	$V_{CE}=25V, V_{GE}=0V,$ $f=1MHz$	-	4.75	-	nF
Reverse Transfer Capacitance	C_{res}		-	0.04	-	
Gate Charge	Q_G	$V_{CC}=520V, I_C=75A,$ $V_{GE}=15V$	-	0.18	-	uC

Switching Characteristic, Inductive Load

Parameter	Symbol	Conditions	Min.	Typ.	Max.	Unit
Dynamic , at T_j= 25°C						
Turn-on Delay Time	t _{d(on)}	V _{CC} =400V, I _C =75A, V _{GE} = -5V~15V, R _g =10Ω, Inductive Load	-	31	-	ns
Rise Time	t _r		-	80	-	ns
Turn-on Energy	E _{on}		-	2.49	-	mJ
Turn-off Delay Time	t _{d(off)}		-	121	-	ns
Fall Time	t _f		-	47	-	ns
Turn-off Energy	E _{off}		-	0.99	-	mJ
Total switching energy	E _{ts}		-	3.48	-	mJ
Dynamic , at T_j= 125°C						
Turn-on Delay Time	t _{d(on)}	V _{CC} =400V, I _C =75A, V _{GE} = -5V~15V, R _g =10Ω, Inductive Load	-	29	-	ns
Rise Time	t _r		-	84	-	ns
Turn-on Energy	E _{on}		-	2.57	-	mJ
Turn-off Delay Time	t _{d(off)}		-	134	-	ns
Fall Time	t _f		-	66	-	ns
Turn-off Energy	E _{off}		-	1.29	-	mJ
Total switching energy	E _{ts}		-	3.86	-	mJ
Dynamic , at T_j= 150°C						
Turn-on Delay Time	t _{d(on)}	V _{CC} =400V, I _C =75A, V _{GE} = -5V~15V, R _g =10Ω, Inductive Load	-	28	-	ns
Rise Time	t _r		-	85	-	ns
Turn-on Energy	E _{on}		-	2.62	-	mJ
Turn-off Delay Time	t _{d(off)}		-	142	-	ns
Fall Time	t _f		-	73	-	ns
Turn-off Energy	E _{off}		-	1.41	-	mJ
Total switching energy	E _{ts}		-	4.03	-	mJ

Electrical Characteristics of the DIODE

Parameter	Symbol	Conditions	Min.	Typ.	Max.	Unit
Static						
Diode Forward Voltage	V_F	$I_F=75A$ $T_j=25^{\circ}C$, $T_j=175^{\circ}C$		1.70 2.60	1.90	V
Diode Capacitive Charge	Q_C	$V_R=400V$, $T_j=25^{\circ}C$		135		nC
Diode Capacitance	C	$f=1MHz$ $V_R=0V$, $V_R=200V$ $V_R=400V$		2453 247 243		pF

Thermal Resistance

Parameter	Symbol	Max. Value	Unit
IGBT Thermal Resistance, Junction - Case	$R_{th(j-c)}$	0.35	K/W
Diode Thermal Resistance, Junction - Case	$R_{th(j-c)}$	0.50	K/W
Thermal Resistance, Junction - Ambient	$R_{th(j-a)}$	40	K/W

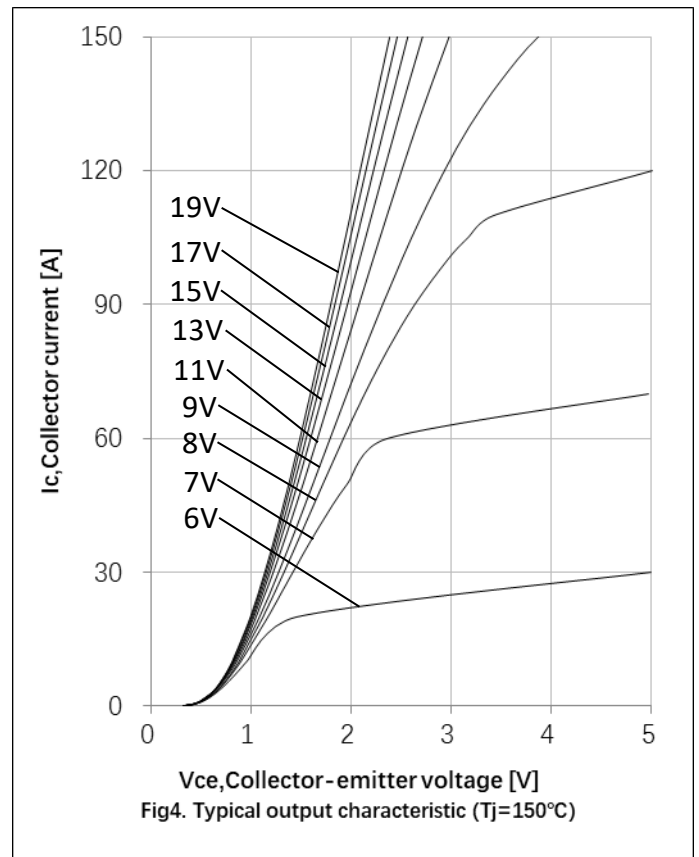
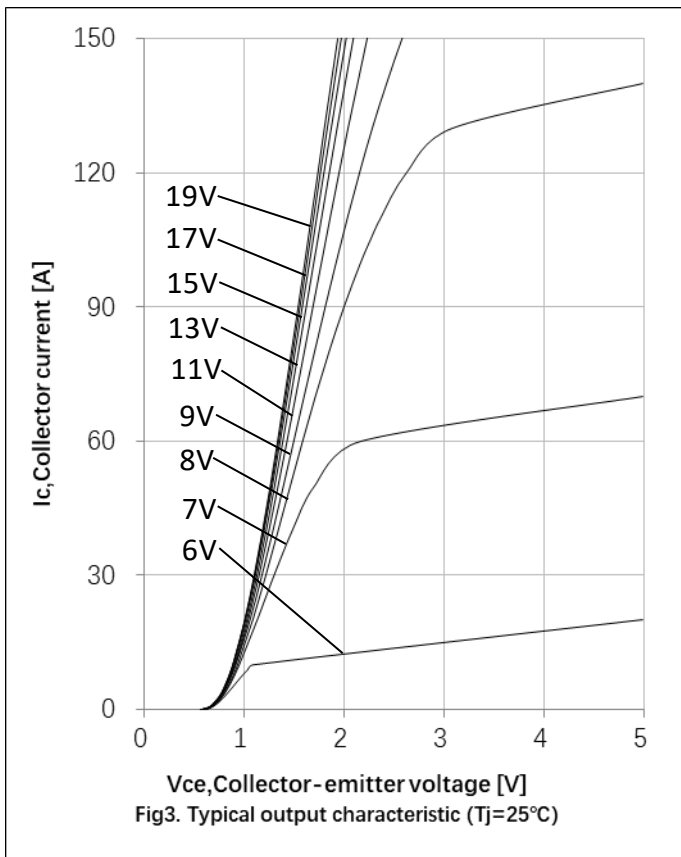
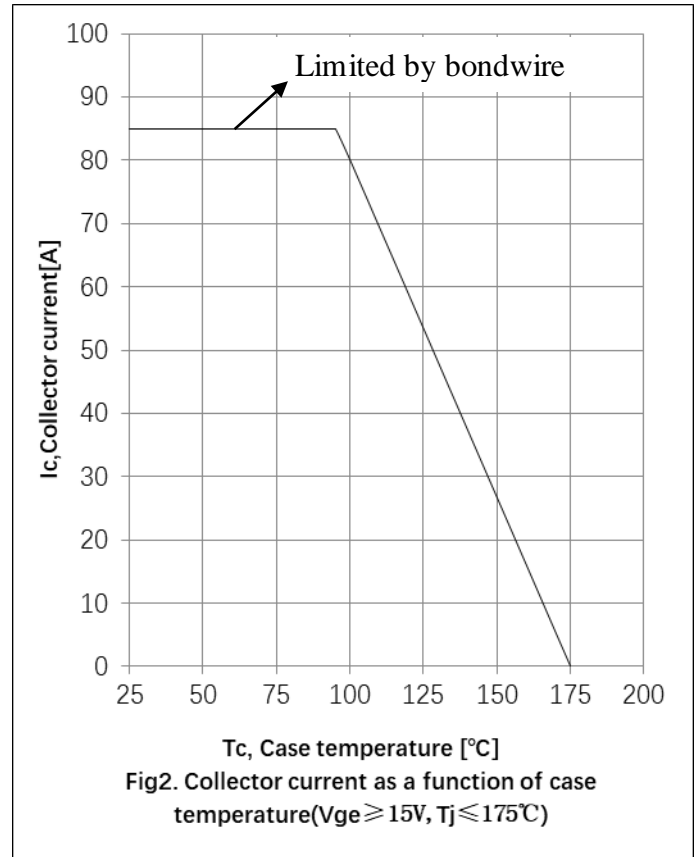
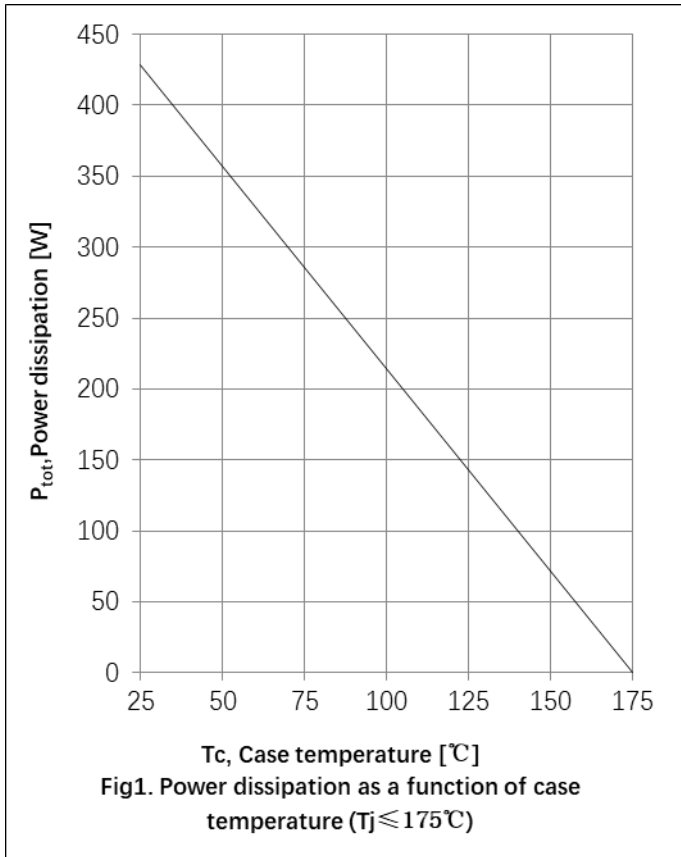

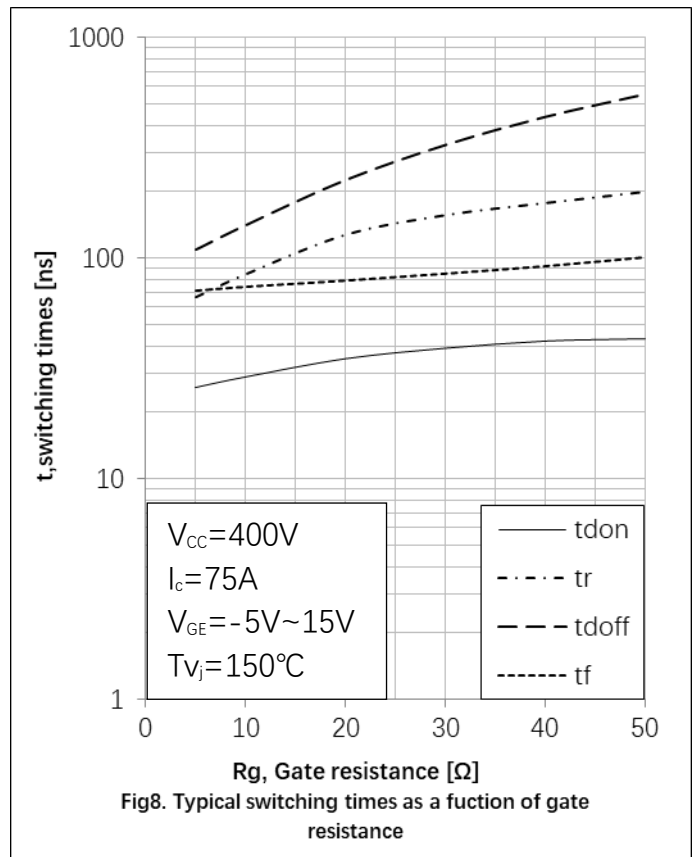
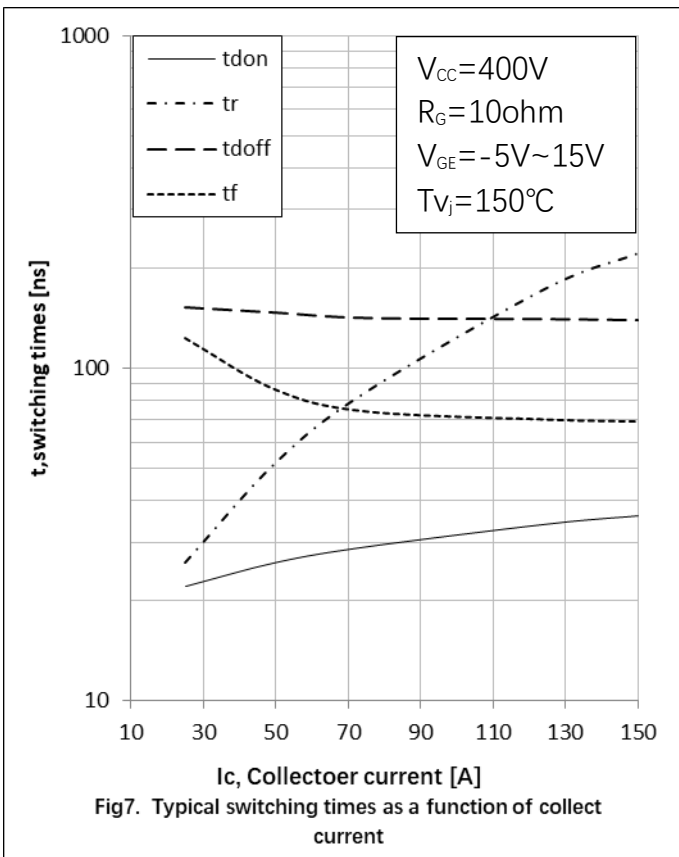
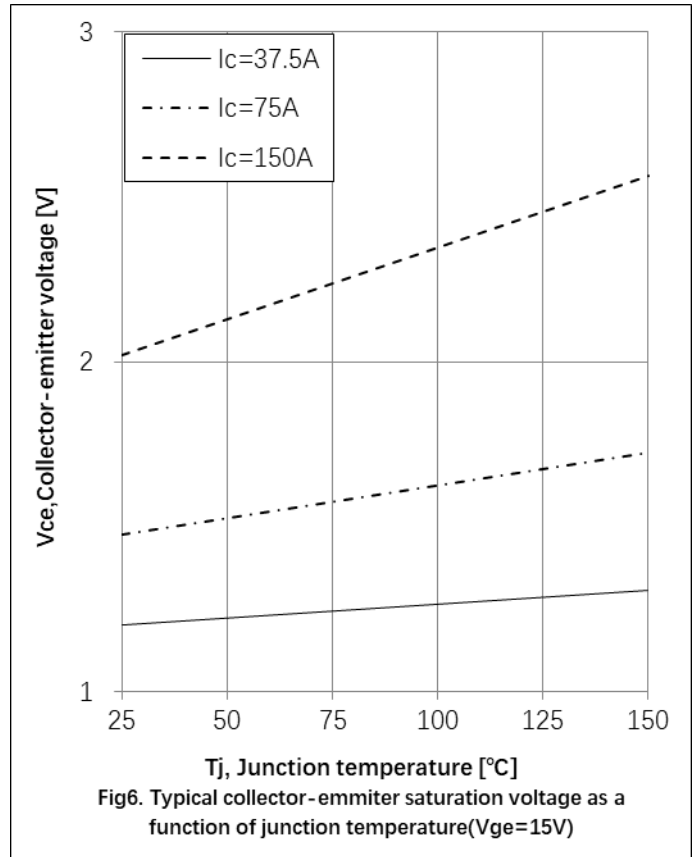
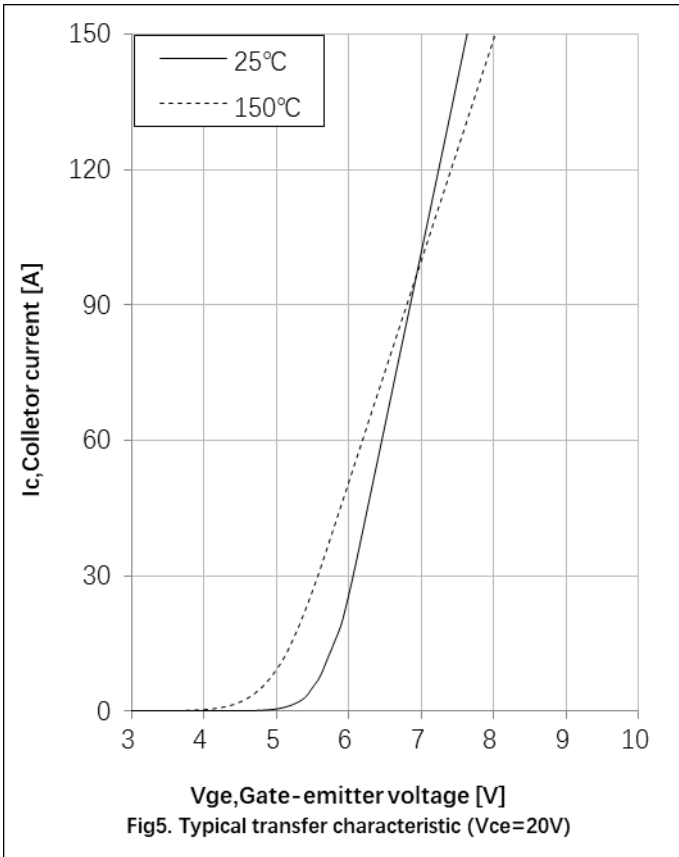

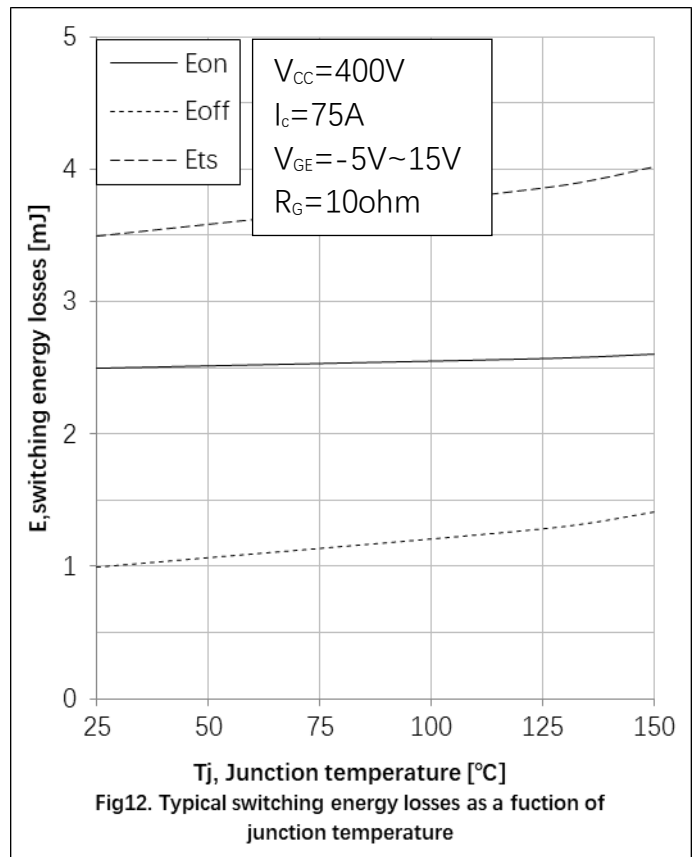
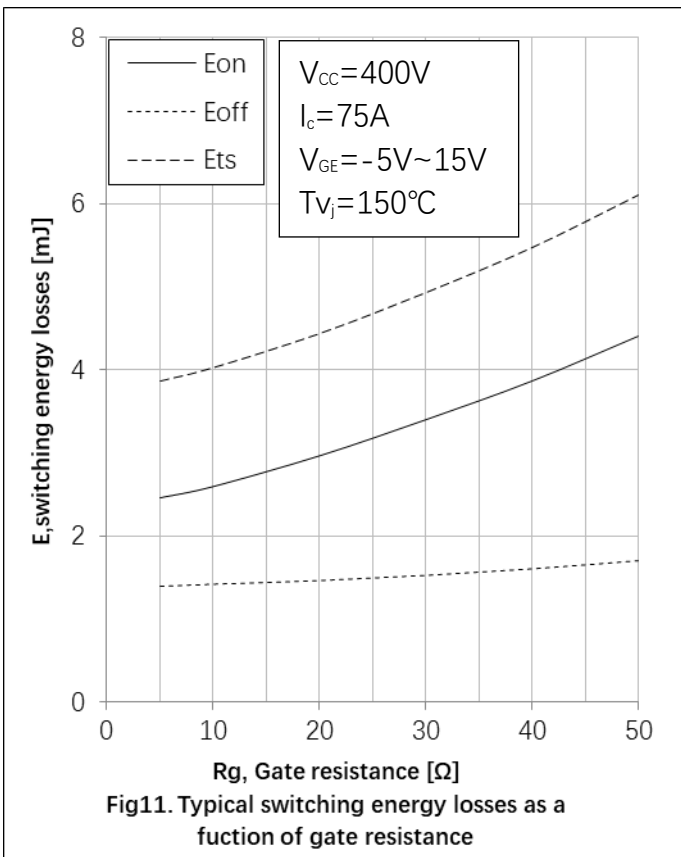
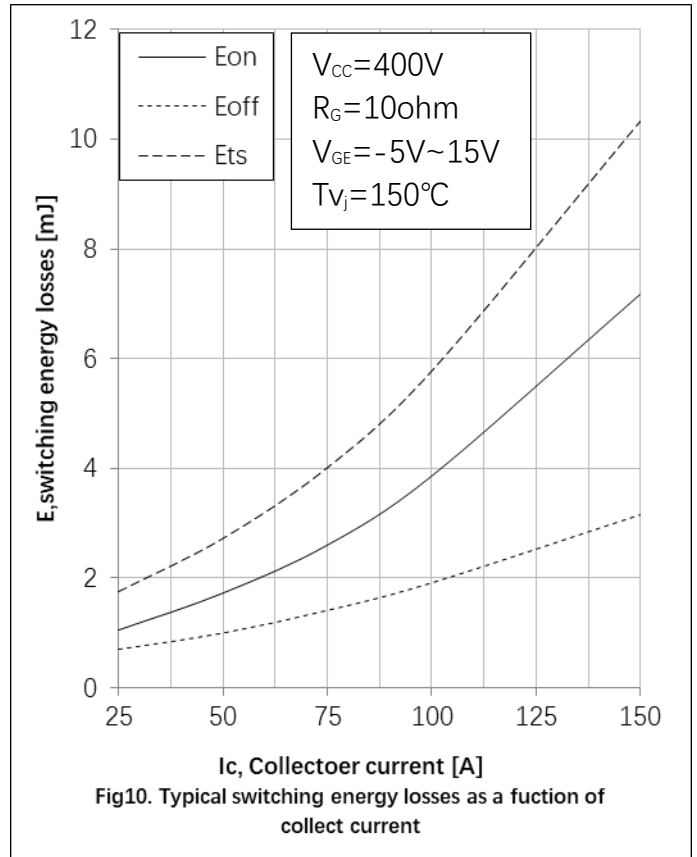
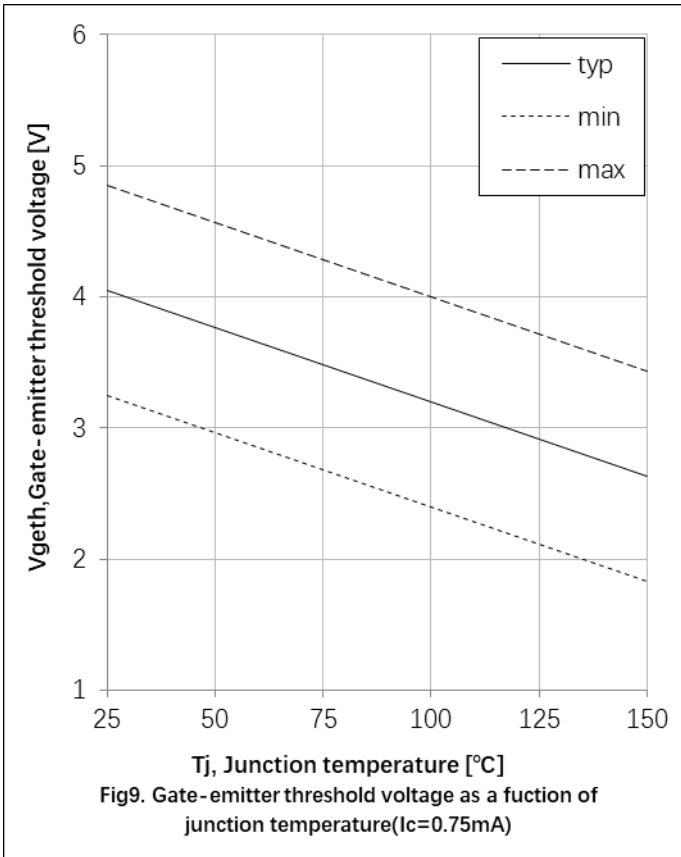

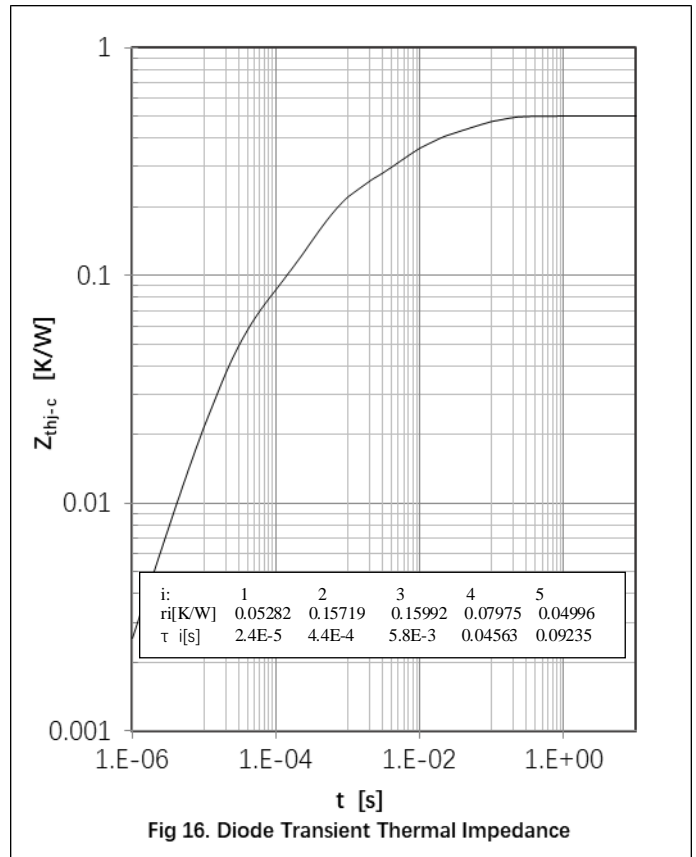
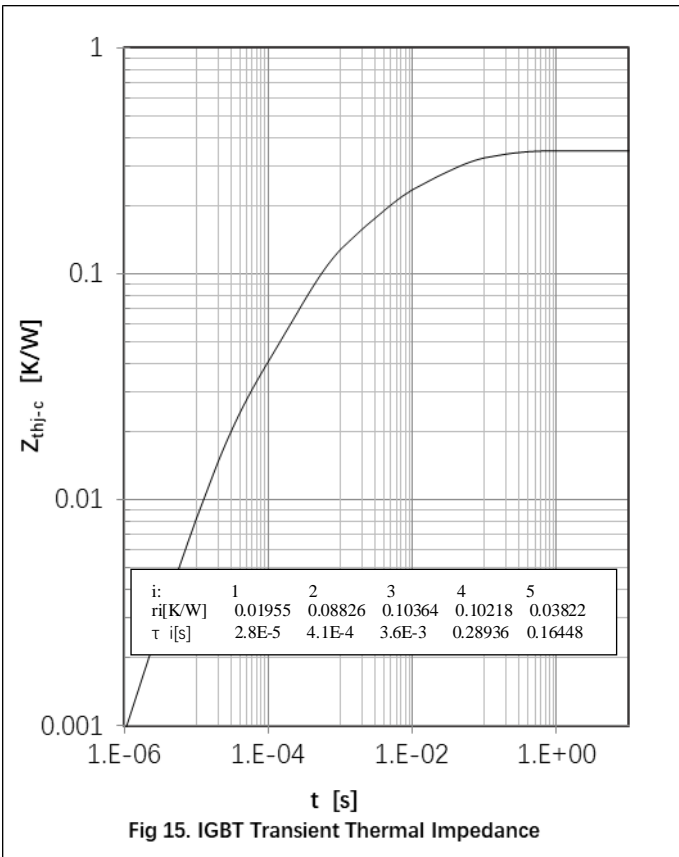
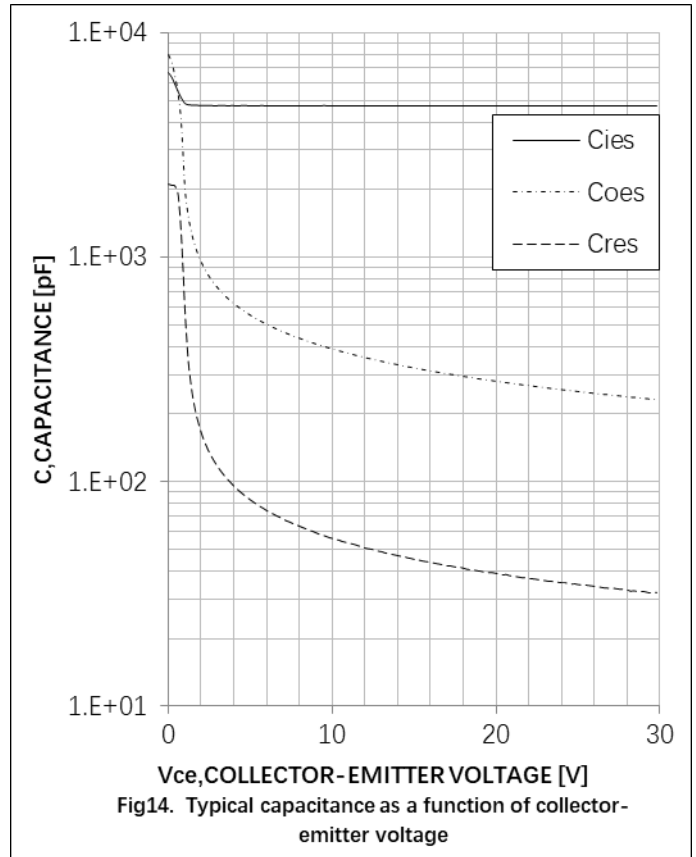
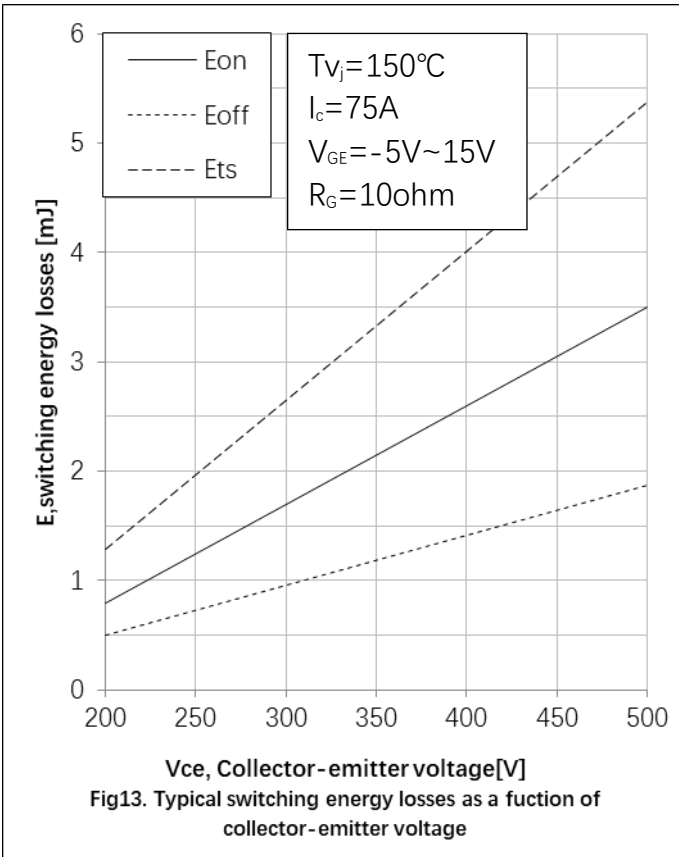

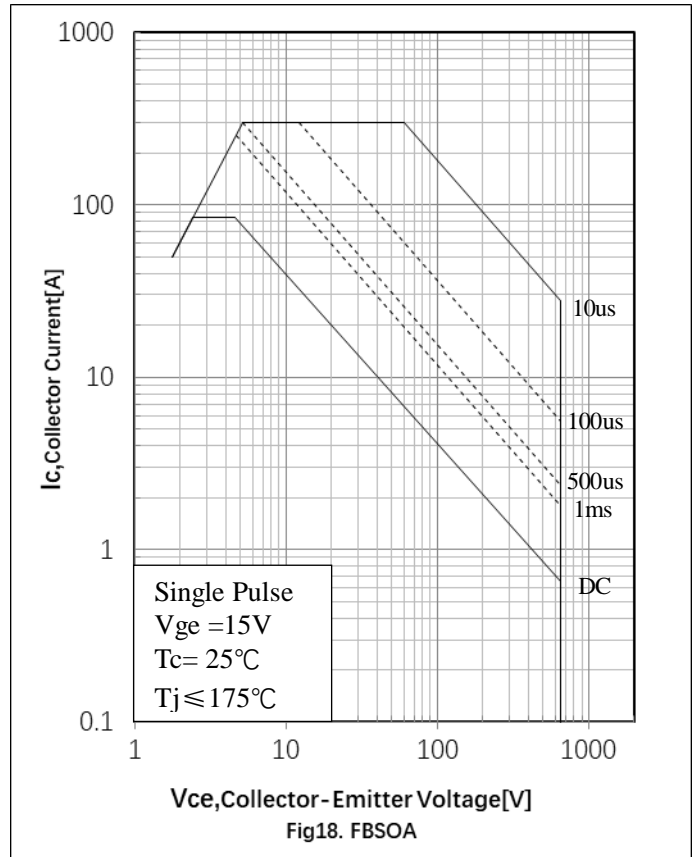
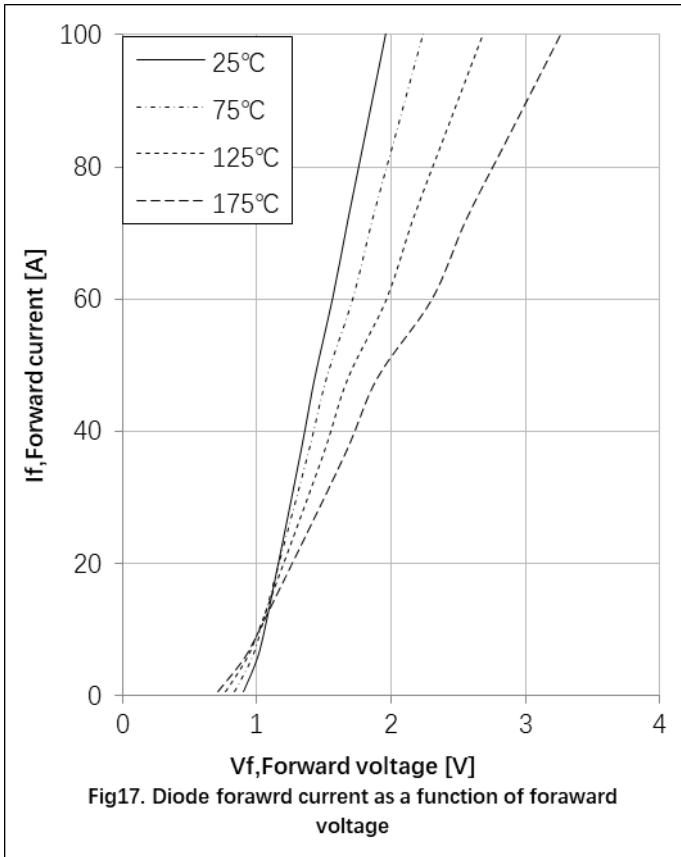

● Circuit Diagram

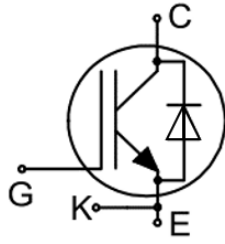

● Package Outline Information

CASE: TO 247-4L

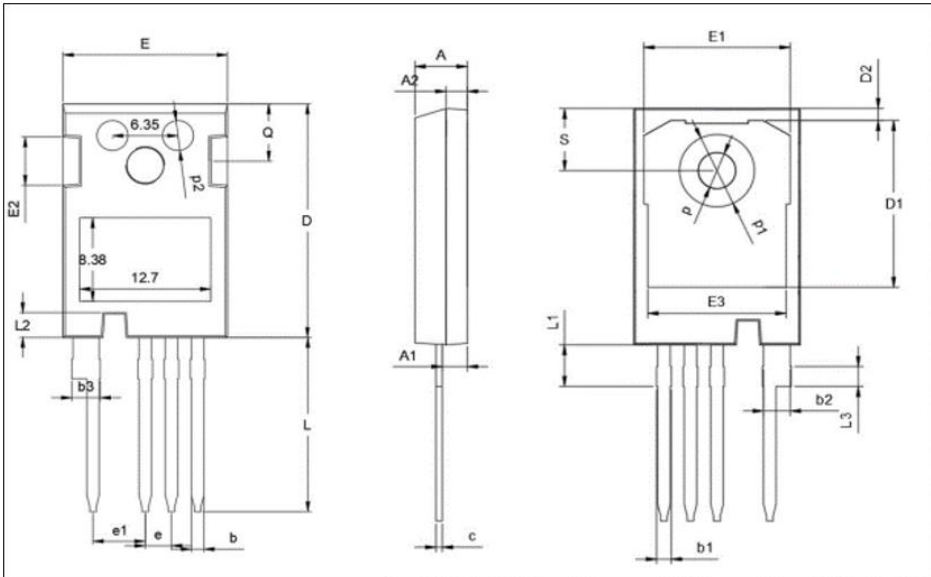

TO247-4L			
Dim	Min	Norm	Max
A	4.80	5.00	5.20
A1	2.30	2.40	2.50
A2	1.88	1.98	2.08
b	1.10	1.20	1.30
b1	1.20	/	1.50
b2	2.35	2.55	2.75
b3	2.45	/	2.85
c	0.55	0.60	0.65
D	23.3	23.45	23.6
D1	16.25	16.55	16.85
D2	1.00	/	1.30
e	TYP2.54		
e1	TYP5.06		
E	15.75	15.90	16.05
E1	13.80	/	14.20
E2	4.40	4.75	5.10
E3	13.00	/	13.45
L	17.34	17.49	17.64
L1	4.00	/	4.30
L2	2.35	/	2.65
L3	TYP1.98		
Q	5.60	5.80	6.00
S	6.05	/	6.30
p	TYP3.58		
p1	TYP7.18		
p2	TYP3.00		