

DGF20N65CTL0

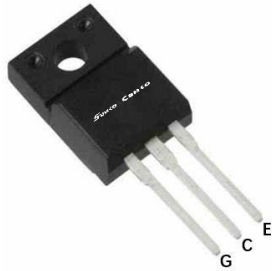

IGBT Discrete

V_{CE}	650	V
I_C	20	A
$V_{CE(SAT)} I_C=20A$	1.60	V

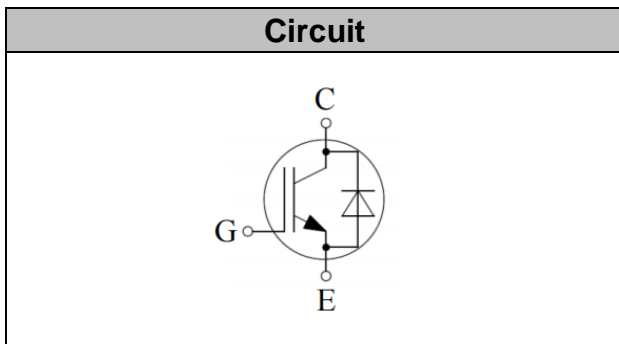

Applications

- Soft switching applications
- Air conditioning
- Motor drive inverter

Features

- High speed smooth switching device for hard & soft switching
- Maximum junction temperature 175°C
- Positive temperature coefficient
- High ruggedness, temperature stable

Maximum Ratings

Parameter	Symbol	Value	Unit
Collector-Emitter Breakdown Voltage	V_{CE}	650	V
DC Collector Current, limited by T_{jmax} $T_C=25^{\circ}C$ $T_C=100^{\circ}C$	I_C	25 15	A
Diode Forward Current, limited by T_{jmax} $T_C=25^{\circ}C$ $T_C=100^{\circ}C$	I_F	25 15	A
Continuous Gate-Emitter Voltage	V_{GE}	± 20	V
Transient Gate-Emitter Voltage ($t_p \leq 10\mu s, D < 0.010$)	V_{GE}	± 30	V
Turn off Safe Operating Area $V_{CE} \leq 600V,$ $T_j \leq 150^{\circ}C$		60	A
Pulsed Collector Current, $V_{GE}=15V,$ t_p limited by T_{jmax}	I_{CM}	60	A
Short Circuit Withstand Time, $V_{GE}=15V,$ $V_{CE} \leq 400V$	T_{SC}	5	μs
Diode Pulsed Current, t_p limited by T_{jmax}	I_{Fpuls}	60	A
Power Dissipation, $T_j=175^{\circ}C, T_c=25^{\circ}C$	P_{tot}	37	W

Operating Junction Temperature	T_j	-40...+175	°C
Storage Temperature	T_s	-55...+150	°C
Soldering Temperature, wave soldering 1.6mm (0.063in.) from case for 10s		260	°C

Electrical Characteristics of the IGBT ($T_j=25^\circ\text{C}$ unless otherwise specified):

Parameter	Symbol	Conditions	Min.	Typ.	Max.	Unit
Static						
Collector-Emitter Breakdown Voltage	BV_{CES}	$V_{GE}=0V, I_C=250\mu A$	650		-	V
Gate Threshold Voltage	$V_{GE(th)}$	$V_{GE}=V_{CE}, I_C=1mA$	5.0	5.8	6.5	V
Collector-Emitter Saturation Voltage	$V_{CE(sat)}$	$V_{GE}=15V, I_C=20A$ $T_j=25^\circ\text{C}$, $T_j=125^\circ\text{C}$ $T_j=150^\circ\text{C}$		1.60 1.75 1.80	1.95	V
Zero Gate Voltage Collector Current	I_{CES}	$V_{CE}=650V, V_{GE}=0V$ $T_j=25^\circ\text{C}$, $T_j=150^\circ\text{C}$			0.25 1.00	mA
Gate-Emitter Leakage Current	I_{GES}	$V_{CE}=0V, V_{GE}=\pm 20V$			± 200	nA

Parameter	Symbol	Conditions	Min.	Typ.	Max.	Unit
Dynamic						
Input Capacitance	C_{ies}	$V_{CE}=25V, V_{GE}=0V,$ $f=1MHz$	-	0.90	-	nF
Output capacitance	C_{oes}		-	0.04	-	
Reverse Transfer Capacitance	C_{res}		-	0.01	-	
Gate Charge	Q_G	$V_{CC}=300V, I_C=20A,$ $V_{GE}=15V$	-	0.085	-	μC
Short circuit collector current	$I_{C(SC)}$	$V_{GE}=15V, t_{SC}\leq 5\mu\text{s}$ $V_{CC}=400V,$ $T_{j,start}=25^\circ\text{C}$	-	115	-	A

Electrical Characteristics of the Diode (T_j= 25°C unless otherwise specified):

Parameter	Symbol	Conditions	Min.	Typ.	Max.	Unit
Static						
Diode Forward Voltage	V _F	I _F =20A T _j = 25°C, T _j = 125°C T _j = 150°C		2.00 1.80 1.70	2.50	V

Switching Characteristic, Inductive Load

Parameter	Symbol	Conditions	Min.	Typ.	Max.	Unit
Dynamic , at T_j= 25°C						
Turn-on Delay Time	t _{d(on)}	T _j =25°C V _{CC} = 300V, I _C =20A, V _{GE} =-5V~15V, R _g =51 Ω	-	12	-	ns
Rise Time	t _r		-	33	-	ns
Turn-on Energy	E _{on}		-	0.41	-	mJ
Turn-off Delay Time	t _{d(off)}		-	68	-	ns
Fall Time	t _f		-	129	-	ns
Turn-off Energy	E _{off}		-	0.22	-	mJ
Dynamic , at T_j= 125°C						
Turn-on Delay Time	t _{d(on)}	T _j =125°C V _{CC} = 300V, I _C =20A, V _{GE} =-5V~15V, R _g =51 Ω	-	16	-	ns
Rise Time	t _r		-	41	-	ns
Turn-on Energy	E _{on}		-	0.48	-	mJ
Turn-off Delay Time	t _{d(off)}		-	69	-	ns
Fall Time	t _f		-	154	-	ns
Turn-off Energy	E _{off}		-	0.35	-	mJ
Dynamic , at T_j= 150°C						
Turn-on Delay Time	t _{d(on)}	T _j =150°C V _{CC} = 300V, I _C =20A, V _{GE} =-5V~15V, R _g =51 Ω	-	18	-	ns
Rise Time	t _r		-	49	-	ns
Turn-on Energy	E _{on}		-	0.52	-	mJ
Turn-off Delay Time	t _{d(off)}		-	69	-	ns
Fall Time	t _f		-	173	-	ns
Turn-off Energy	E _{off}		-	0.38	-	mJ

Electrical Characteristics of the DIODE

Parameter	Symbol	Conditions	Min.	Typ.	Max.	Unit
Dynamic , at T_j= 25°C						
Reverse Recovery Current	I _{rr}	I _F =20A, V _R =300V, -di/dt= 360A/μs,	-	6	-	A
Diode reverse recovery time	t _{rr}		-	200	-	ns
Reverse Recovery Charge	Q _{rr}		-	0.25	-	uC
Reverse Recovery Energy	E _{rec}		-	0.07	-	mJ
Dynamic , at T_j= 125°C						
Reverse Recovery Current	I _{rr}	I _F =20A, V _R =300V, -di/dt= 360A/μs,	-	8	-	A
Diode reverse recovery time	t _{rr}		-	218	-	ns
Reverse Recovery Charge	Q _{rr}		-	0.59	-	uC
Reverse Recovery Energy	E _{rec}		-	0.13	-	mJ
Dynamic , at T_j= 150°C						
Reverse Recovery Current	I _{rr}	I _F =20A, V _R =300V, -di/dt= 360A/μs,	-	9	-	A
Diode reverse recovery time	t _{rr}		-	227	-	ns
Reverse Recovery Charge	Q _{rr}		-	0.78	-	uC
Reverse Recovery Energy	E _{rec}		-	0.16	-	mJ

Thermal Resistance

Parameter	Symbol	Max. Value	Unit
IGBT Thermal Resistance, Junction - Case	R _{th(j-c)}	4.0	K/W
Diode Thermal Resistance, Junction - Case	R _{th(j-c)}	4.8	K/W
Thermal Resistance, Junction - Ambient	R _{th(j-a)}	60	K/W

DGF20N65CTL0

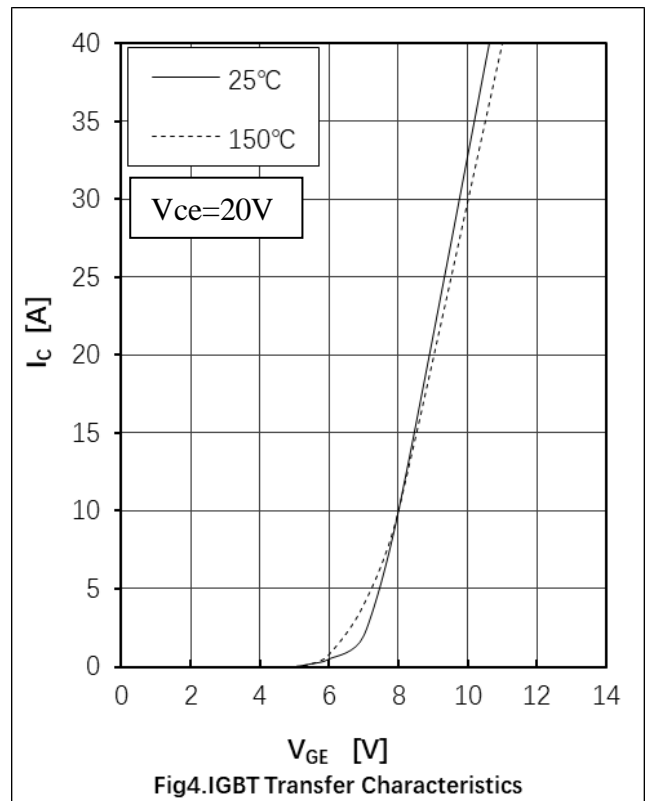
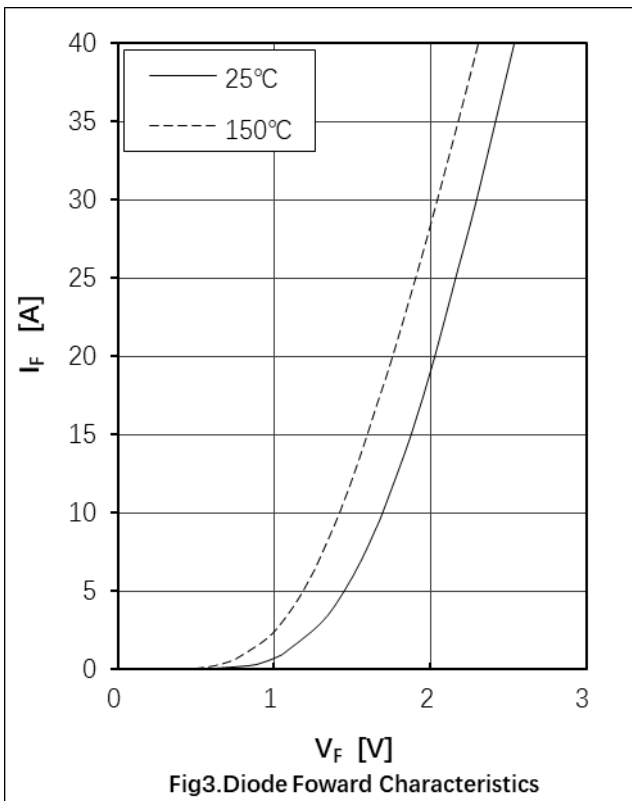
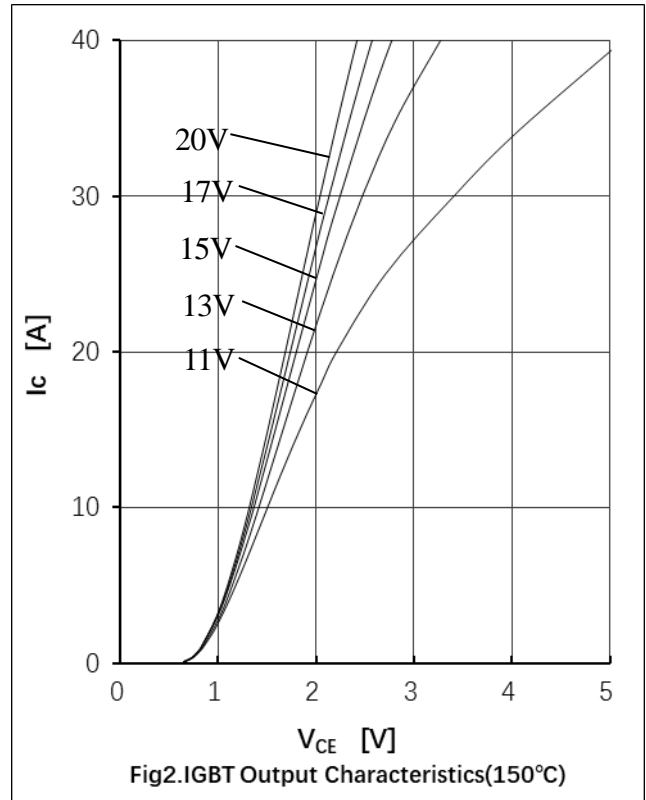
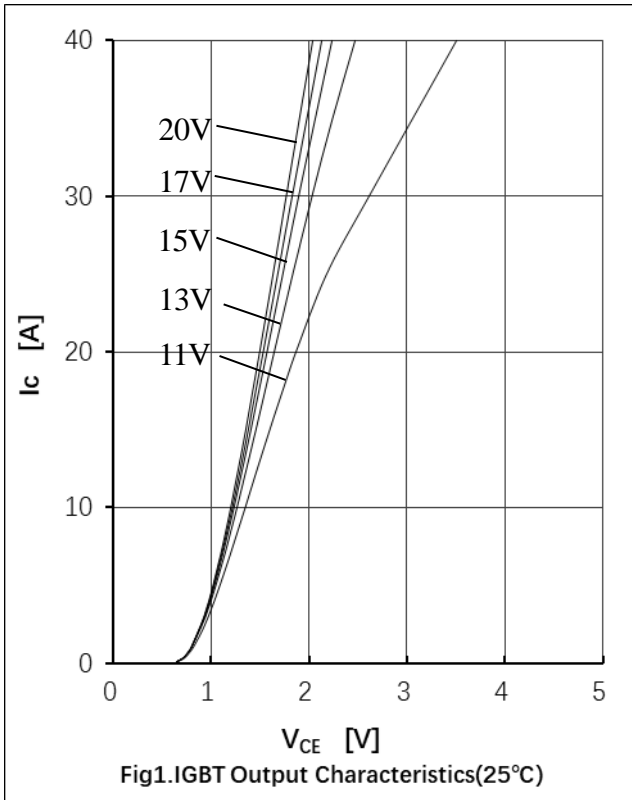

DGF20N65CTL0

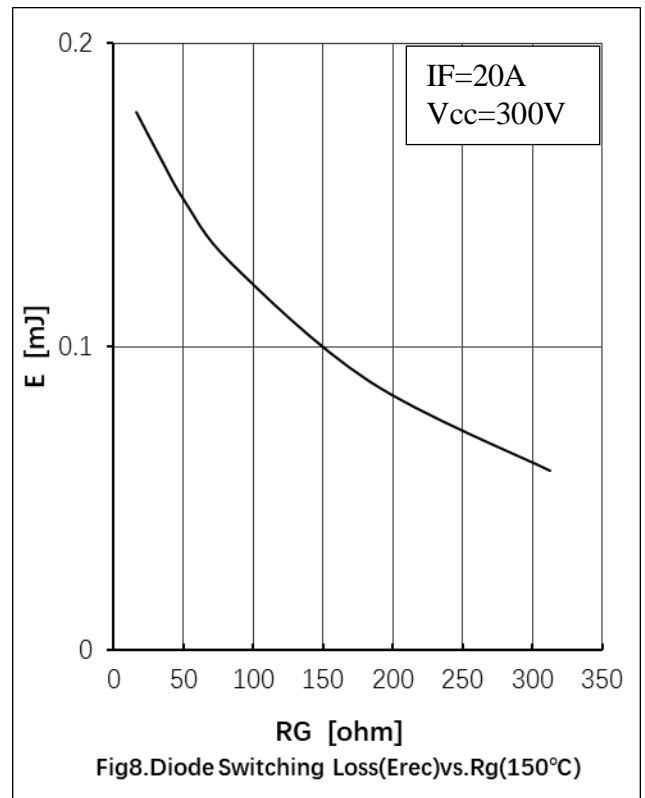
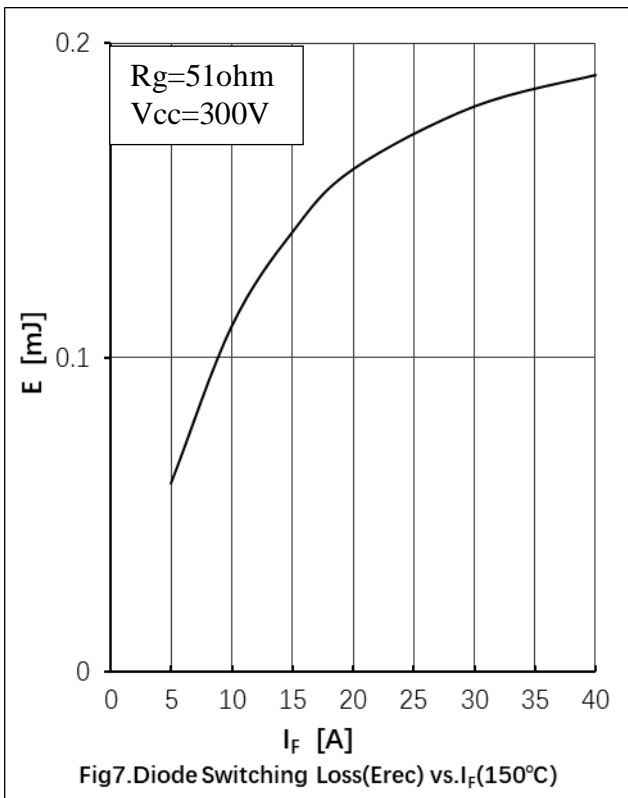
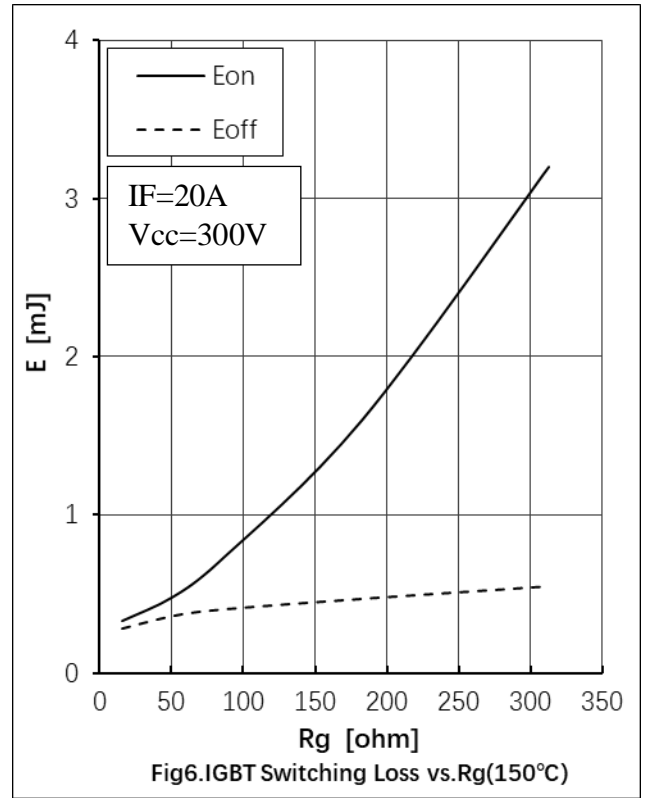
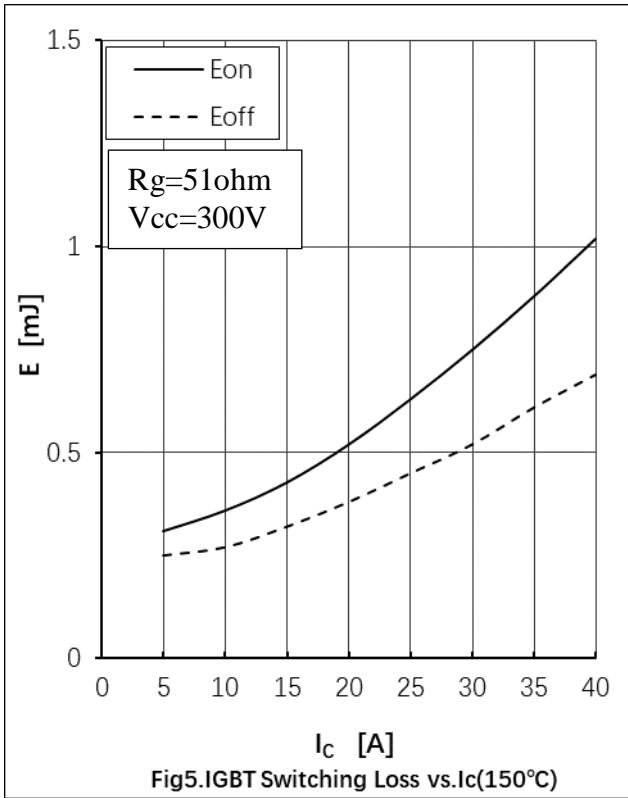

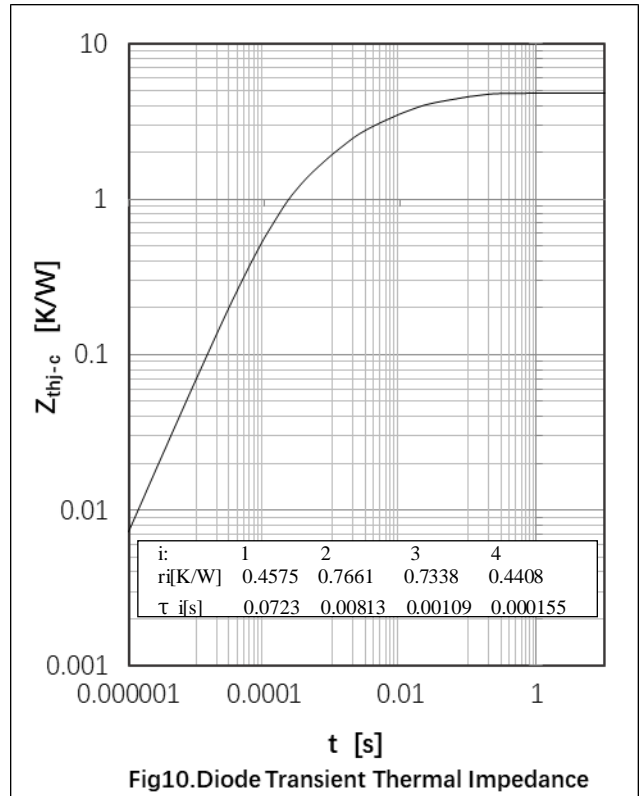
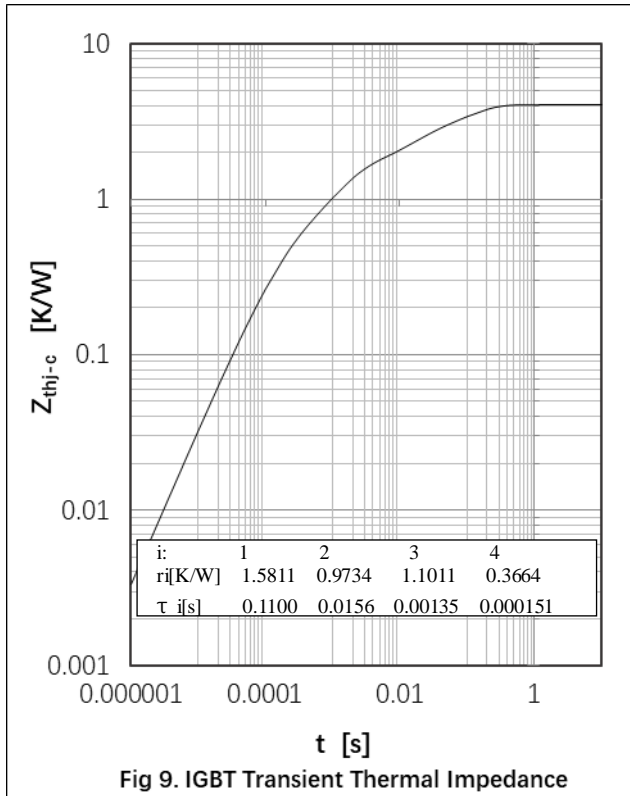

● Circuit Diagram

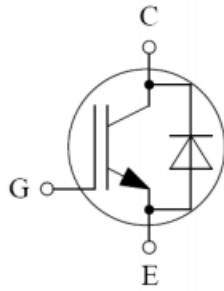

● Package Outline Information

CASE: TO-220F package information

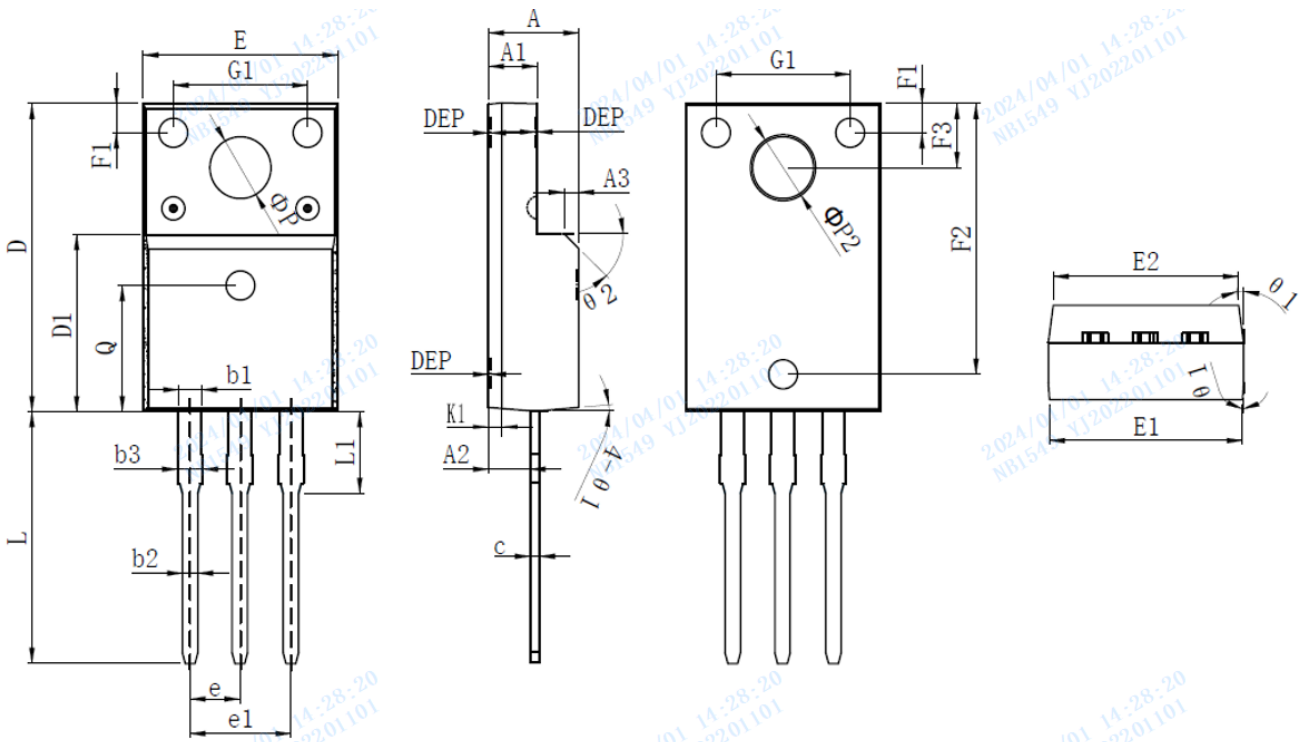

SYMBOL	单位: mm			SYMBOL	单位: mm			SYMBOL	单位: mm		
	MIN	NOM	MAX		MIN	NOM	MAX		MIN	NOM	MAX
A	4.40	4.50	4.60	E	10.00	10.16	10.30	ΦP2	3.30	3.40	3.50
A1	2.34	2.54	2.74	E1	9.94	10.06	10.20	θ1	3°	5°	7°
A2	2.66	2.76	2.86	E2	9.40	9.50	9.60	θ2	42°	45°	48°
A3	1.0REF			F1	1.40	1.50	1.60				
b1	1.18	1.20	1.24	F2	13.80	13.90	14.00				
b2	0.75	0.80	0.85	F3	3.20	3.30	3.40				
b3	1.22	1.30	1.38	G1	6.90	7.00	7.10				
C	0.45	0.50	0.55	K1	0.65	0.70	0.75				
D	15.67	15.87	16.07	L	12.78	12.98	13.18				
D1	9.04	9.12	9.20	L1	3.40	3.50	3.60				
e	2.50	2.54	2.58	Q	6.50REF						
e1	5.08REF			ΦP	3.08	3.18	3.28				

Disclaimer

The information presented in this document is for reference only. Shanghai Sunco Electronics Co., Ltd. reserves the right to make changes without notice for the specification of the products displayed herein to improve reliability, function or design or otherwise.

The product listed herein is designed to be used with ordinary electronic equipment or devices, and not designed to be used with equipment or devices which require high level of reliability and the malfunction of which would directly endanger human life (such as aerospace machinery, nuclear-reactor controllers, fuel controllers and other safety devices), Russiansunco or anyone on its behalf, assumes no responsibility or liability for any damages resulting from such improper use of sale.

This publication supersedes & replaces all information previously supplied. For additional information, please visit our website [http:// www.russiansunco.com](http://www.russiansunco.com) , or consult your nearest Russiansunco's sales office for further assistance.